



We make it visible.

User  
 User ID:  
  
 Password:  
  
  
[> NEW? Register now!](#)  
[> Forgot Password?](#)

- Applications**
- > Biomedical Applications
  - > Materials Applications
- Microscopes**
- > Upright microscopes
  - > Inverted microscopes
  - > Stereomicroscopes
  - > Zoom Microscopes
- Computers**
- > Computers
- Software**
- > AxioVision Software
  - > ZEN Software
- Accessories**
- > Accessories
- Tools**
- > Camera Assistant
  - > Filter Assistant
  - Objective Assistant
- Further Products**
- > Service

Carl Zeiss Microscopy, LLC  
 One Zeiss Drive  
 Thornwood, NY 10594  
 United States

micro@zeiss.com  
 +1 800 233 2343

- Visit us on:
- Facebook
  - Twitter
  - YouTube

Delivery is free.



powered by VeriSign

© 2006-2013 Carl Zeiss

Microscopy & Imaging | Online Shop

Carl Zeiss Microscopy, LLC, United States

Homepage | Basket | Contact | Carl Zeiss Worldwide

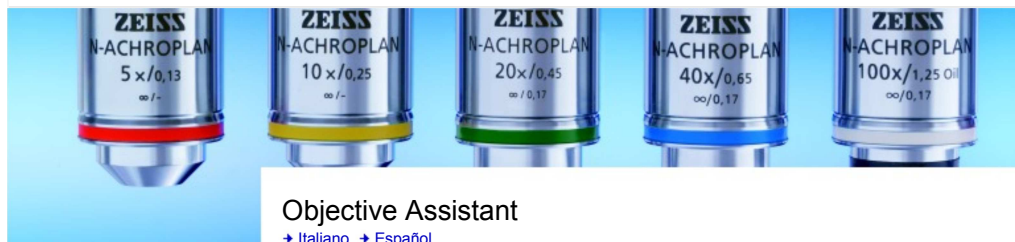

## Objective Assistant

[→ Italiano](#) [→ Español](#)

[→ Objective Assistant](#) [→ List of Objectives](#)

Print

### Objective data

Brochure: Objectives from Carl Zeiss (5 MB)

**Objective Class: LD Plan-Neofluar**

Objectives for inverted research microscopy with long working distance →



→ Transmittance curve

**Objective LD Plan-Neofluar 40x/0.6 Corr M27**

421360-9970-000

Price	<a href="#">→ Price</a>
Magnification	40x
Numerical Aperture	0.6
Working Distance [mm]	2.9 at cover glass 0.75
Coverglass Thickness [mm]	0-1.5
Thread Type	M27x0.75
Immersion	Without Immersion
Field of View [mm]	23
Parfocal Length [mm]	45.06
Long Distance (LD)	■
Correction Ring (Korr)	■
Iris (Iris)	
Optical System	Infinity Color Corrected System (ICS)
Flatness	★★★★
Color Correction	★★★★

#### Biomedical Applications

Fluorescence	■
- Multichannel	★★★★
- Ultraviolet Transmission	★★★★
- Infra Red Transmission	★★★
BrightField (H)	■
Differential Interference Contrast (DIC)	★★★★
High Contrast DIC (HC DIC)	
PlasDIC Contrast	■
Phase Contrast (PH)	
VAREL Contrast	
Hoffman Modulation Contrast (HMC)	
Polarization Contrast (POL)	

#### Materials (Reflected Light) Applications

BrightField (H)	
BrightField/DarkField (HD)	
Reflected Light DIC (RL DIC)	
High Contrast DIC (HC DIC)	
DIC with circular polarized light (C-DIC)	
Total Interference Contrast (TIC)	
Polarization Contrast (POL)	
<b>Options</b>	
Confocal Microscopy	■
- Ultra Violet	★★★★
- VIS (visible light)	★★★★
NLO-IR / 2 Photon	★★
Total Internal Reflection Fluorescence (TIRF)	

#### Objective LD Plan-Neofluar 40x/0.6 Corr M27



(D=0-1.5mm) (WD=3.3mm at D=0mm and WD=2.5mm at D=1.5mm)

#### Mechanical Dimensions

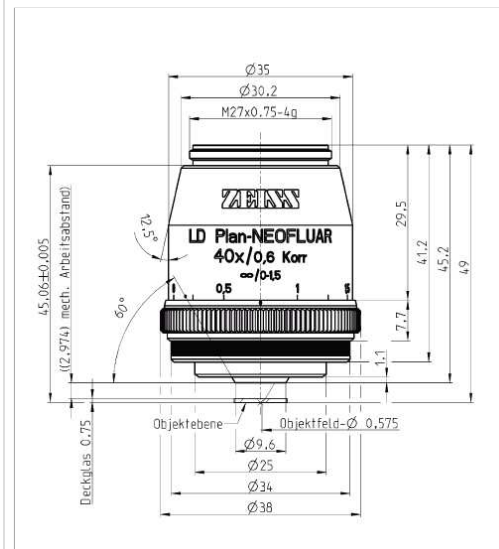

All measures in [mm]

mech. Arbeitsabstand = mechanical working distance  
 Deckglas = cover glass  
 Objektenebene = object plane  
 Objektfeld = object field  
 Ausleuchtung = illumination  
 Probenzugänglichkeit = specimen accessibility

#### Transmittance curve

ApoTome	
Microdissection	■

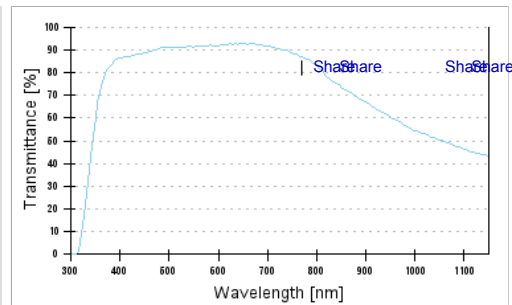

Please note that due to production tolerances, the given values are typical only and not guaranteed.

**Fitting Accessories for**  
421360-9970-000 Objective LD Plan-Neofluar 40x/0.6 Corr M27

[More](#) | [Share](#) | [Share](#)

**DIC sliders**

**The contents of the basket can be:**  
 + ordered online  
 + printed as a fax order  
 + requested as a written quotation  
 + saved as a shopping list

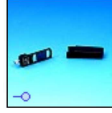

**PlasDIC slider for LD PN 40x/0.60 corr**  
Order Number: 444505-0000-000

[Compatibility](#) | [Basket](#)



**DIC slider LD PN 40x/0.60 II**  
Order Number: 426955-0000-000

[Compatibility](#) | [Basket](#)

**Other Accessories**



**Adapter 30mm with optics and DIC slider mount**  
Order Number: 424516-9040-000  
for adaptation of objectives M27 with parfocal length of 45 mm

**Note: This item is no longer available.**

[Compatibility](#)

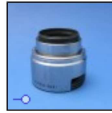

**Adapter 30mm with optics and DIC slider mount**  
Order Number: 424516-9041-000  
for adaptation of objectives M27 with parfocal length of 45mm

[Compatibility](#) | [Basket](#)



**Objective ring ACR for objective sleeve conical long**  
Order Number: 424510-0000-000

[Compatibility](#) | [Basket](#)